

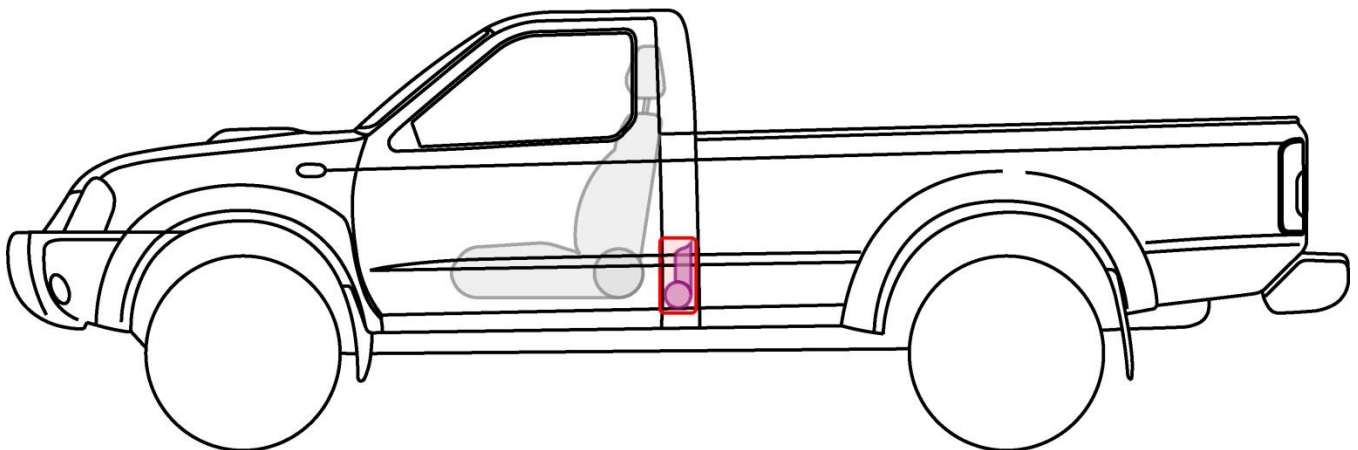

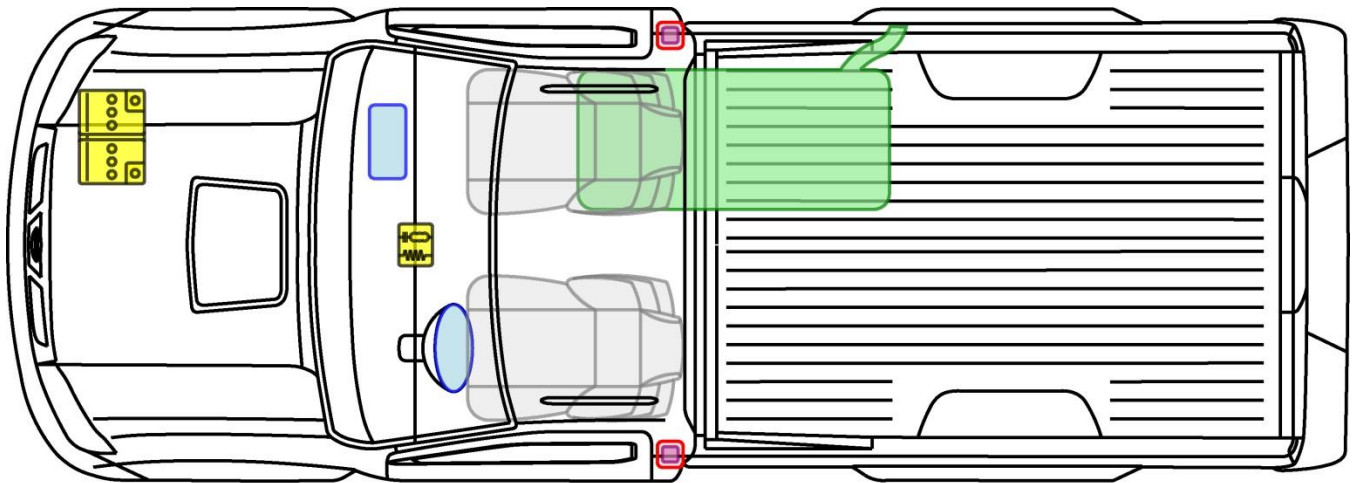





NP300 Single Cab

Typ: D22, 2008-2011

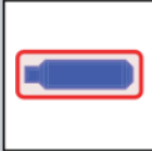

Legenda

	Poduszka powietrzna		Wzmocnienia konstrukcji nadwozia		Moduł sterujący
	Generator gazowy		Aktywna ochrona w przypadku wywrócenia pojazdu		Akumulator 12V
	Napinacz pasa bezpieczeństwa		Amortyzator gazowy		Zbiornik paliwa

NP300